

- Ⓐ Colector drenaje 2"
2" Drainage manifold
- Ⓑ Colector entrada 8"
8" Inlet manifold
- Ⓒ Colector salida 8"
8" Outlet manifold

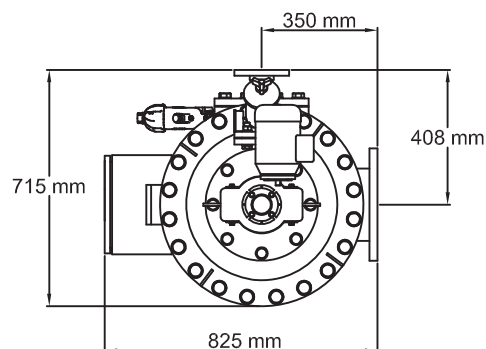

AZUD LUXON LDB 12300/8

SCALE S/E A4 FORMAT	MATERIAL:	RESPONS.: M. Martínez	AZUD
	UNITS: mm.	REVISION: 00	
	FILE: Azud_luxon_LDB_12300-8.dwg	04/05/2012	